



Quality Parts

GRUPPO 5 & 6 Cilindri

25

5 & 6 Cylinders FAMILY

CATALOGO RICAMBI ALTERNATIVI PER

MOTORI KUBOTA

NON ORIGINAL PARTS CATALOGUE FOR

KUBOTA ENGINES

REL 1010

Questo catalogo contiene dati ed informazioni provenienti dalla pluriennale esperienza di Finimpianti. Tuttavia non possiamo assumere alcuna responsabilità per eventuali dati errati od incompleti.

Tutti i dati e le informazioni contenute nel presente catalogo sono fornite a puro scopo informativo e senza responsabilità e non potranno dare adito ad alcuna forma di risarcimento.

Visto il continuo sviluppo dei nostri prodotti, Finimpianti si riserva il diritto di apportare modifiche senza preavviso.

Denominazioni, numeri e codici originali sono riportati a puro titolo di riferimento.

All the information and data contained in this catalogue came from the long Finimpianti experience. Nevertheless we can not assume any responsibility for possible mistakes.

All the information and data contained in this catalogue are provide "as is" without any representation or warranty express or implied. Under no circumstances whatsoever shall Finimpianti be liable for any damages whatsoever arising out of the use of the information and data contained in this catalogue.

Finimpianti does not warrant the accuracy or completeness of the materials and content contained in this catalogue and reserves the right to correct any errors or omissions at any time without notice and without obligation to the users of this catalogue.

OEM names, codes and part numbers, used in this catalogue, are for reference only.

GRUPPO 5 & 6 Cilindri
KUBOTA
5 & 6 Cylinders FAMILY

1	F2803
3	S2800

Questo catalogo contiene dati ed informazioni provenienti dalla pluriennale esperienza di Finimpianti. Tuttavia non possiamo assumere alcuna responsabilità per eventuali dati errati od incompleti.

Tutti i dati e le informazioni contenute nel presente catalogo sono fornite a puro scopo informativo e senza responsabilità e non potranno dare adito ad alcuna forma di risarcimento.

Visto il continuo sviluppo dei nostri prodotti, Finimpianti si riserva il diritto di apportare modifiche senza preavviso.

Denominazioni, numeri e codici originali sono riportati a puro titolo di riferimento.

All the information and data contained in this catalogue came from the long Finimpianti experience. Nevertheless we can not assume any responsibility for possible mistakes.



All the information and data contained in this catalogue are provide "as is" without any representation or warranty express or implied. Under no circumstances whatsoever shall Finimpianti be liable for any damages whatsoever arising out of the use of the information and data contained in this catalogue.







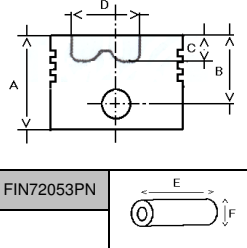

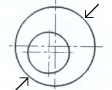
Finimpianti does not warrant the accuracy or completeness of the materials and content contained in this catalogue and reserves the right to correct any errors or omissions at any time without notice and without obligation to the users of this catalogue.

OEM names, codes and part numbers, used in this catalogue, are for reference only.

KUBOTA

F2803	Cm³	CILINDRI CYLINDERS	ALESAGGIO BORE	CORSA STROKE	VERSIONE VERSION
	2746	5	87	92	

		TESTA HEAD	A				
			B				
			C				
			D				
			E				
			F				
	87 87,25 87,5	FIN72003PC00 FIN72003PC025 FIN72003PC05	FIN72103RS00 FIN72103RS025 FIN72103RS05				

		Nr.						ADATTABILE A: SUITABLE FOR:	
---	---	------------	---	---	---	---	---	--------------------------------	---

CR		5						STD-0,20-0,40-0,50	FIN73107CR STD
----	--	---	--	--	--	--	--	--------------------	----------------

MB		1						STD-0,20-0,40-0,50	FIN75107MB STD
----	--	---	--	--	--	--	--	--------------------	----------------





MB		5						STD-0,20-0,40-0,50	FIN75108MB STD
----	--	---	--	--	--	--	--	--------------------	----------------



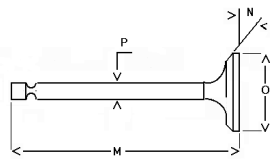

--	--	--	--	--	--	--	--	--	--

PB		5						SEMIF.	FIN72703PB
----	--	---	--	--	--	--	--	--------	------------

TWS		1						STD	FIN76103TWS STD
-----	--	---	--	--	--	--	--	-----	-----------------

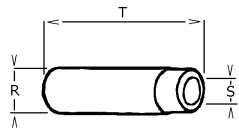

--	--	--	--	--	--	--	--	--	--







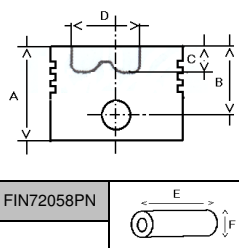

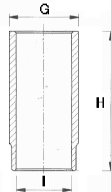
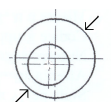
	IN		Nr.	O	P	M	N		ADATTABILE A: SUITABLE FOR:						
	EX								5						FINA74005
	EX								5						FINS74006

	IN		Nr.	R	S	T		ADATTABILE A: SUITABLE FOR:					
	IN							5					FIN78103AA
	IN												
	EX							5					FIN78104SA
EX													

KUBOTA

S2800	Cm³	CILINDRI CYLINDERS	ALESAGGIO BORE	CORSA STROKE	VERSIONE VERSION
	2791	6	85	82	

		TESTA HEAD A B C D E F		TIPO TYPE 	CL	
					G	
					H	
					I	
					FIN72058PN	
					FIN72125RS00	
	85	SEE NEXT PAGE	VEDI PAG.SEGUENTE	FIN72125RS05		
	85,5	SEE NEXT PAGE	VEDI PAG.SEGUENTE	FIN72220SL02		

		Nr.						ADATTABILE A: SUITABLE FOR:	
---	---	------------	---	---	---	---	---	--------------------------------	---

CR		6						STD-0,20-0,40-0,50	FIN73112CR STD
----	--	---	--	--	--	--	--	--------------------	----------------

MB		1						STD-0,20-0,40-0,50	FIN75107MB STD
----	--	---	--	--	--	--	--	--------------------	----------------





MB		6						STD-0,20-0,40-0,50	FIN75108MB STD
----	--	---	--	--	--	--	--	--------------------	----------------



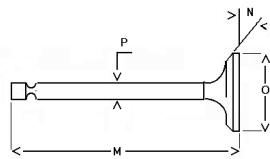

--	--	--	--	--	--	--	--	--	--

PB		6						SEMIF.	FIN72113PB
----	--	---	--	--	--	--	--	--------	------------



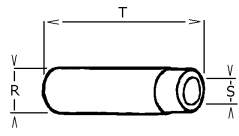

TWS		1						STD	FIN76103TWS STD
-----	--	---	--	--	--	--	--	-----	-----------------

--	--	--	--	--	--	--	--	--	--

	IN EX		Nr.	O	P	M	N		ADATTABILE A: SUITABLE FOR:						
	IN								6						FINA74015
	EX								6						FINS74016

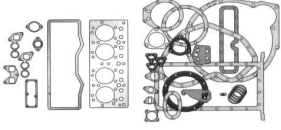
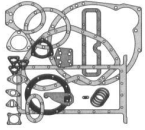
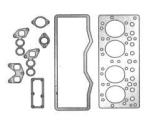
	IN EX		Nr.	R	S	T		ADATTABILE A: SUITABLE FOR:					
	IN							6					FIN78103AA
	IN												
	EX							6					FIN78104SA
	EX												



KUBOTA					
S2800	Cm³	CILINDRI CYLINDERS	ALESAGGIO BORE	CORSA STROKE	VERSIONE VERSION
	2791	6	85	82	

					
FIN77227CGA	FIN77127BMA	FIN77327SM	FIN76557HG		

Nr.	ENGINE OVERHAUL KIT			

Nr.	PISTON & LINER SET	

Nr.	CONROD BEARINGS SET	
6		FIN73112CR STD
		FIN73132CRS STD

Nr.	MAIN BEARINGS SET	
1		FIN75107MB STD
6		FIN75108MB STD
		FIN75134MBS STD

CRS + MBS + TWS = CMS	
	FIN75162CMS

1	Filtro Olio	Oil Filter	FIN75068OF
2	Filtro Combustibile	Fuel Filter	FIN75514FE
3	Pompa Acqua	Water Pump	FIN74119WP
4	Pistone Completo STD pos. 1 & 2 & 6	Piston Assembly STD pos. 1 & 2 & 6	FIN72035PC00
5	Pistone Completo STD pos. 3 & 4 & 5	Piston Assembly STD pos. 3 & 4 & 5	FIN72038PC00
6	Pistone Completo 05 pos. 1 & 2 & 6	Piston Assembly 05 pos. 1 & 2 & 6	FIN72035PC05
7	Pistone Completo 05 pos. 3 & 4 & 5	Piston Assembly 05 pos. 3 & 4 & 5	FIN72038PC05
8			
9			
10			

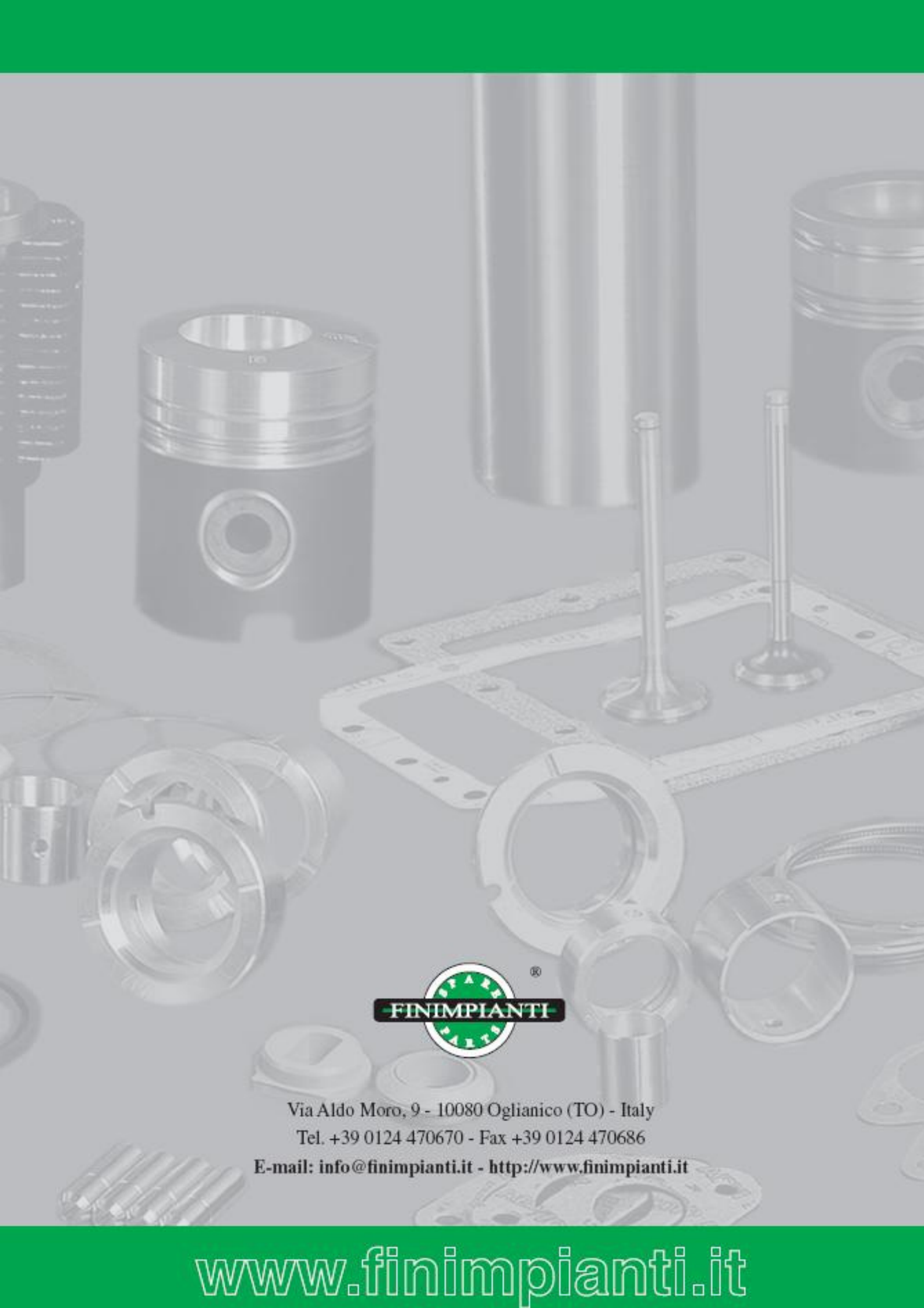

Via Aldo Moro, 9 - 10080 Oglianico (TO) - Italy

Tel. +39 0124 470670 - Fax +39 0124 470686

E-mail: info@finimpianti.it - <http://www.finimpianti.it>

www.finimpianti.it